



# EVEREST

## SIDE CHANNEL BLOWERS



**BI MARKETING®**  
— AND SERVICES P LTD —

*Innovative Engineering  
Solutions!!!*



*Innovative Engineering Solutions!!!*





Everest Group was established in 1980, with the manufacturing of Twin Lobe Rotary Air Blowers (Roots Blowers). Over the years the company has expanded its technology base, bringing a wide range of products. With its corporate office in New Delhi & two state of art manufacturing facilities in Bahadurgarh, Haryana, India, the company is ISO9001:2015 certified which attests its quality. Facilities include in house design, production, manufacturing, quality control, inspection and after sales service.

Sales are through a network of direct sales representatives, distributors and agents. Everest has a complete marketing infrastructure all over India. Inside sales people have years of application experience and are totally capable of helping you determine your best hardware solutions, if questions exist. We provide in-depth technical support both before and after the sale. This support is critical because our products are designed with the flexibility and dependability to provide years of service in cutting edge and demanding applications. A focus on innovative design and high quality machined parts has earned Everest a reputation for excellent workmanship amongst its users. For nearly four decades Everest has offered its customers quality, cost-effective machines necessary to meet the changing technology. Our commitment to total quality in both our products and services is the foundation upon which our future business is based.

**Broad Product Line Serves Wide Variety of Applications:** We know that performance of the OEM's design ultimately depends on the quality and dependability of its components. That's why so many manufacturers of Water Treatment Plants, Effluent Treatment Plants, Cement Plants, Aquiculture Farms, Chemical Plants, Paper Plants, Vacuum Plants and Systems, and Pneumatic Conveying Systems have entrusted their reputation to Everest.



## COMPANY PROFILE

Our broad product line of Roots Blowers (Bi-lobe & Tri-lobe) (Air / Gas Duty), Mechanical Vacuum Boosters, Dry Screw Vacuum Pumps, Acoustic Hoods & Industrial Vacuum Systems consists of standard and custom models that fall into major product group.

The company has recently introduced its Turbo Blowers Vertical wherein new product groups including Side Channel Blowers, Centrifugal Blowers, High Speed Centrifugal Blowers + Air Knife Systems and Turbo Blowers have been added with an idea to provide energy efficient low pressure air solutions to the global industry.

**Engineering Expertise:** As a company structured to serve the OEM's, we understand the critical requirements that each OEM application has in terms of power, space, noise, air flow, vibration, cost and more. With our standard models of Air Blowers and Vacuum Pumps, we're able, through our unique design and engineering expertise, to develop a completely new model, or modify an existing design. The result is a custom air blower or vacuum pump that meets the exact requirements of OEM application at the lowest possible cost.

**Our Commitment To Quality – ISO 9001:2015:** The hallmark of our commitment to quality is our International Standards Organisation (ISO) registration. This ensures that our OEM customers receive products of highest quality.

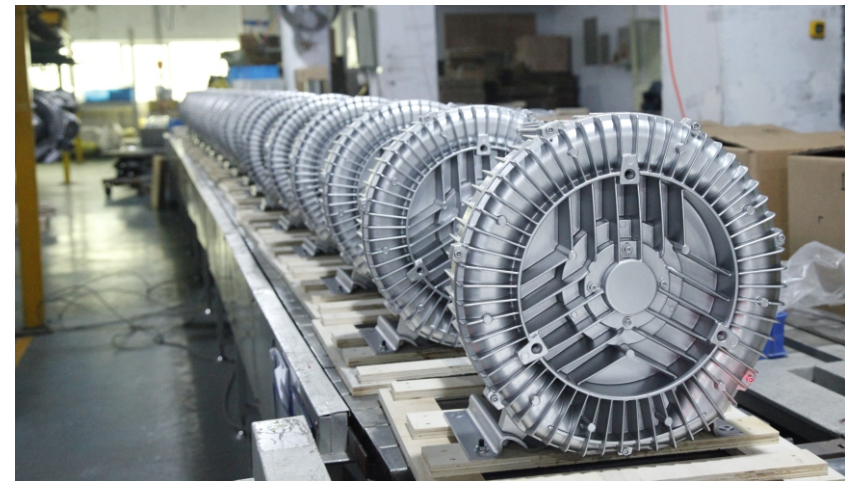



Since EVEREST was established, the company has been a world leader in the design and manufacture of Air Blowers. EVEREST offers a genuine alternative in high-performance air technology equipment.

### **DESIGN AND MANUFACTURE**

Everest products are designed and manufactured in India to ISO 9001 quality standards.

### **RELIABILITY**

To ensure superior reliability, our products are strong and low-maintenance.

### **TESTING**

Everest Product is carefully tested before they leave the factory passing.

### **PRODUCT DELIVERY**

Everest is committed to supplying products quickly and reliably.

### **TECHNICAL SUPPORT AND SERVICE**

Our aim is complete customer satisfaction with fast responses and expert, local advice.

## WORKING PRINCIPLE

A Side Channel Blower is a simple machine to impart momentum to air/gas. Fig (a) shows the basic design concept for a Side Channel Blower, which comprises an impeller with blades located on its periphery that impels the gas through a channel surrounding a toroidal core that extends the length of the perimeter. The gas spirals around the core, interacting with the impeller blades several times before leaving the blower. In this way the Side Channel Blower uses a single impeller to impart multiple stages of pumping to the gas. Referring to Figure 2a, the total pressure of the ventilation gas increases continually as it flows clockwise around the periphery of the blower. The "Stripper seal" shown in the bottom drawing of Fig (a) prevents the high-pressure exit gas from flowing directly into the inlet of the blower. Fig (b) shows a typical impeller from a Side Channel Blower, and Fig (c) provides a side view of a Side Channel Blower impeller and the flow path of gas around the toroidal core.

Side Channel Blowers increase the pressure difference through a series of vortices, which are created by the centrifugal force in the peripheral side channel. The rotation of the impeller leads to the rotation of the gas trapped within the chamber. Additionally the centrifugal force forces the gas into narrow side channel. This causes spiral shaped vortices in the side channel. The vortices lead to the pressure rise of the gas, along the whole length of the side channel. The rotating parts of the ring blower do not touch the housing, eliminating friction and the need for lubrication, which would cause machine failure. The pressure build up is extremely without oil hence there is no pollution of the gas.

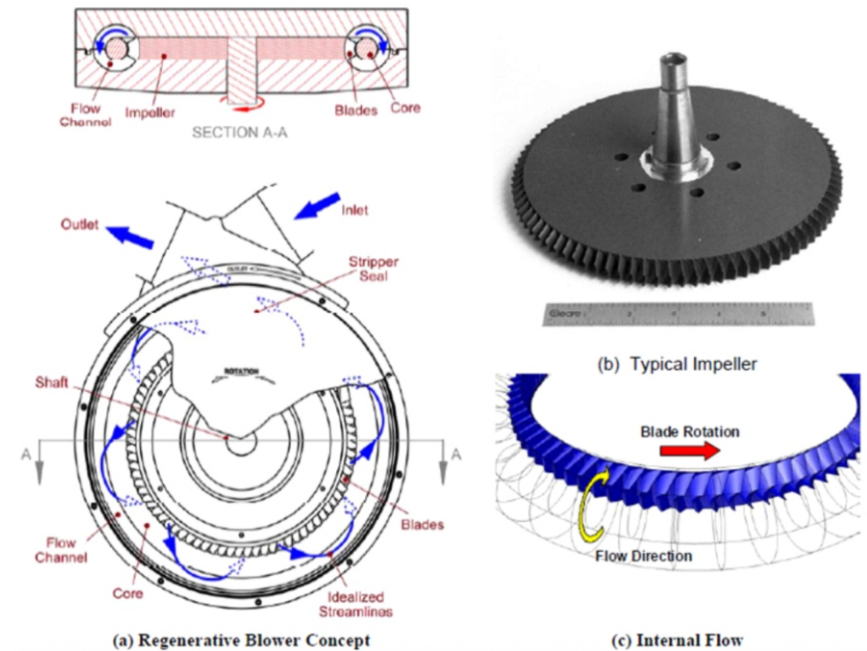



The impellers are mounted directly on the motor shaft for non-contact compression, entirely without friction. Maximum operational reliability, even at high differential pressures, is ensured by the arrangement of the bearings outside the compression chamber. The gas is taken through the Inlet 1. As it enters the Side channel 2, the rotating Impeller 3 imparts velocity to the gas in the direction of rotation. Centrifugal force in the impeller blades accelerates the gas outward and the pressure increases. Every rotation adds kinetic energy, resulting in the further increase of the pressure along the side channel. The side channel narrows at the discharge, sweeping the gas off the impeller blades and discharging it through the Outlet Silencer 4, where it exits the side channel blower.

Side Channel Blowers work according to the Impulse Principle. This means that the kinetic energy from a rotating impeller is transferred to the pumping medium and converted into pressure. The motor rated power determines the maximum differential pressure of the blower. The two silencers fitted to the inlet and discharge sides ensure quiet operation. Unlike positive displacement blowers (pulsating flow), Side Channel Blowers have a continuous flow of air / gas.

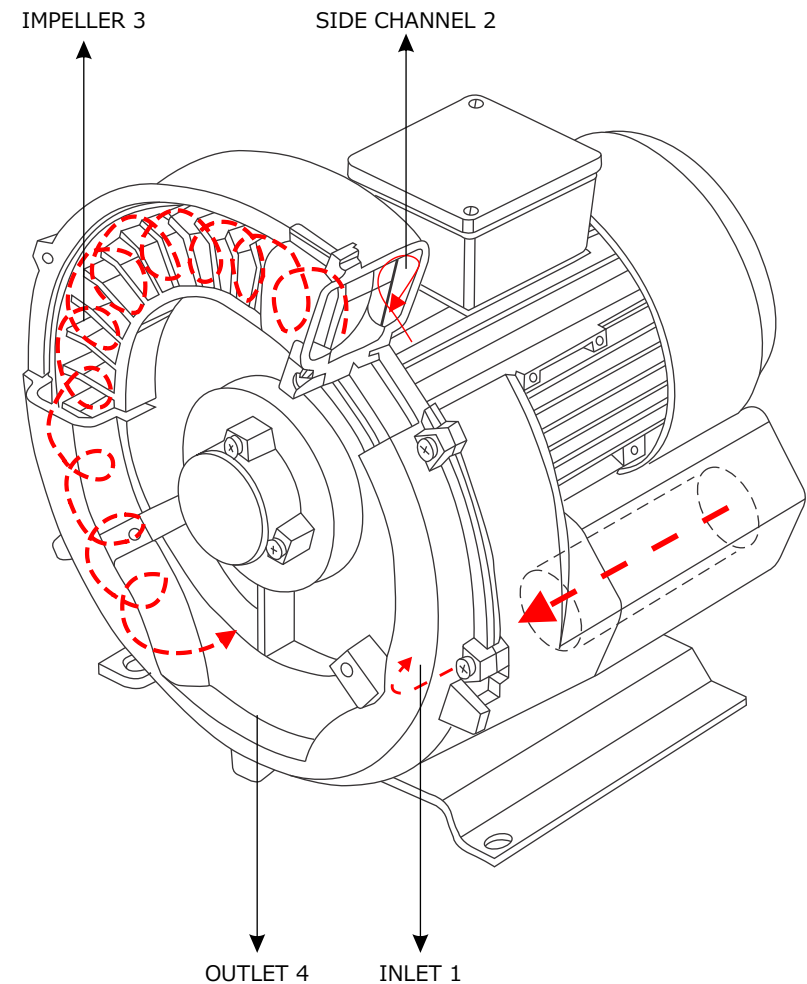

**PICTURES OF EVEREST TURBO  
SIDE CHANNEL BLOWERS**

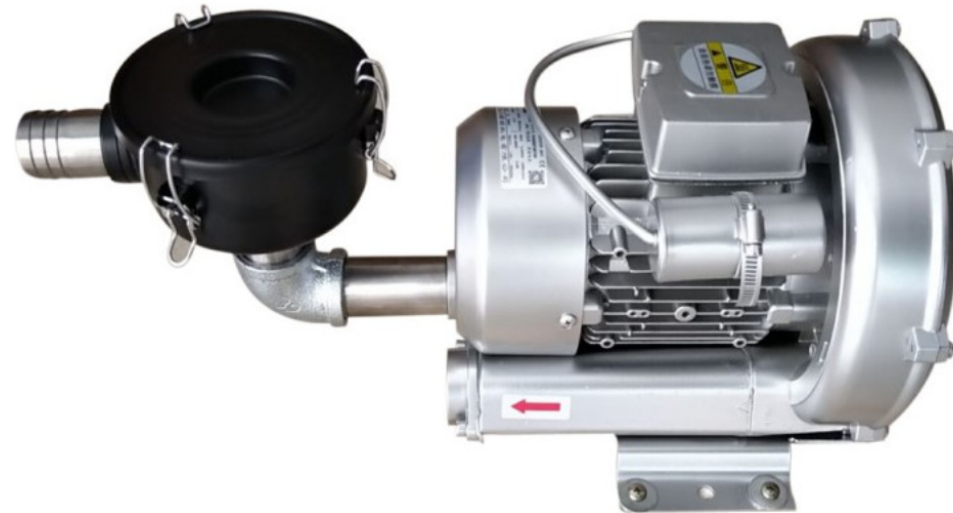
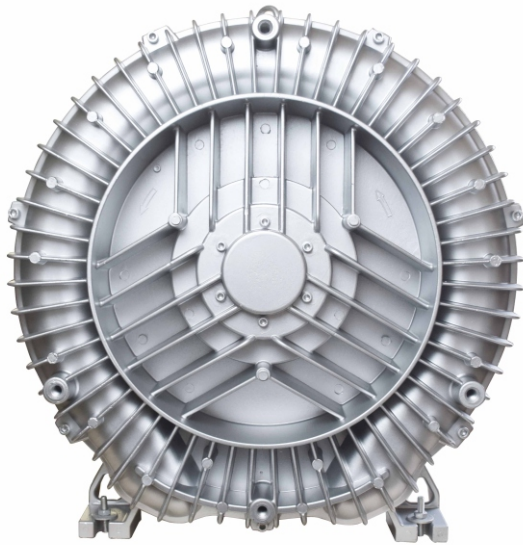
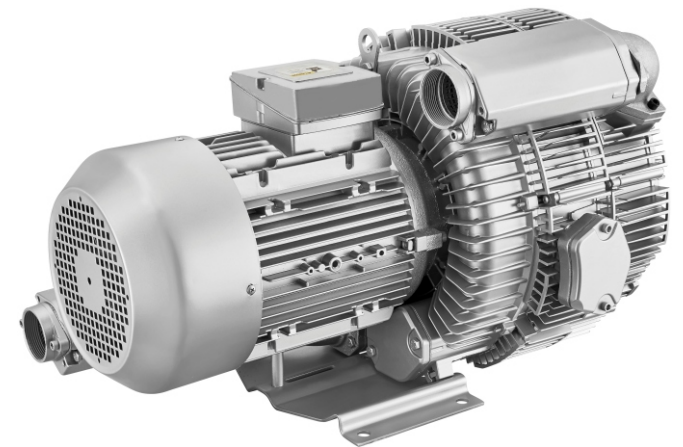





## 2ETS - SINGLE AND DOUBLE STAGE

## PERFORMANCE DATA FOR SIDE CHANNEL BLOWERS IN VACUUM AND PRESSURE OPERATION

MODEL	SINGLE/ THREE PHASE	SINGLE/ DOUBLE/ STAGE	BLOWER OPENING DETAILS	FREQUENCY (Hz)	MOTOR INPUT POWER (kW)	VOLUME FLOW RATE (m <sup>3</sup> /hr)	VACUUM (mbar)	PRESSURE (mbar)	NOISE LEVEL @ 1mt dB(A)	WEIGHT (kg)	FILTER	RELIEF VALVE
2ETS-210-A11	SINGLE	SINGLE	G1¼ (15 Deep)	50	0.37	80	-110	110	53	11	ESF-10	RV-01
2ETS-310-A01	SINGLE	SINGLE	G1¼ (15 Deep)	50	0.55	100	-120	120	55	13	ESF-10	RV-01
2ETS-310-A11	SINGLE	SINGLE	G1¼ (15 Deep)	50	0.7	100	-150	150	55	14	ESF-10	RV-01
2ETS-410-A01	SINGLE	SINGLE	G1½ (15 Deep)	50	0.7	145	-120	120	60	15	ESF-12	RV-01
2ETS-410-A11	SINGLE	SINGLE	G1½ (15 Deep)	50	0.8	145	-150	160	63	15	ESF-12	RV-01
2ETS-410-A21	SINGLE	SINGLE	G1½ (15 Deep)	50	1.1	145	-150	190	63	16	ESF-12	RV-01
2ETS-420-A31	SINGLE	DOUBLE	G1½ (15 Deep)	50	1.5	150	-280	290	66	26	ESF-12	RV-01
2ETS-510-A11	SINGLE	SINGLE	55 mmNB	50	1.1	210	-160	160	64	21	ESF-12	RV-01
2ETS-510-A21	SINGLE	SINGLE	55 mmNB	50	1.5	210	-190	200	64	24	ESF-12	RV-01
2ETS-610-A11	SINGLE	SINGLE	56 mmNB	50	2.2	270	-230	250	64	30	ESF-12	RV-01
2ETS-710-A11	SINGLE	SINGLE	55 mmNB	50	2.2	318	-190	190	72	30	ESF-16	RV-01

Specification are subject to change without notice. Side Channel Blowers are also available with motors suitable for 60 Hz frequency and different operating voltages. Contact Everest for further details.



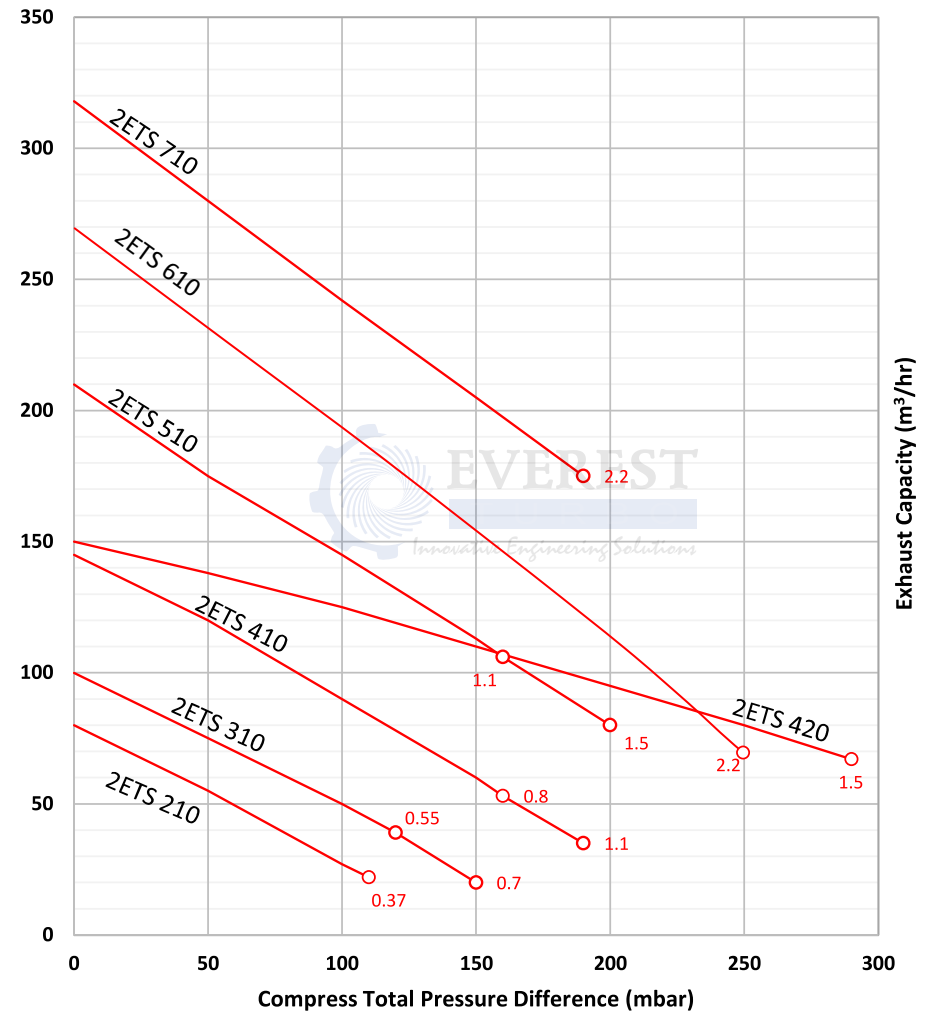
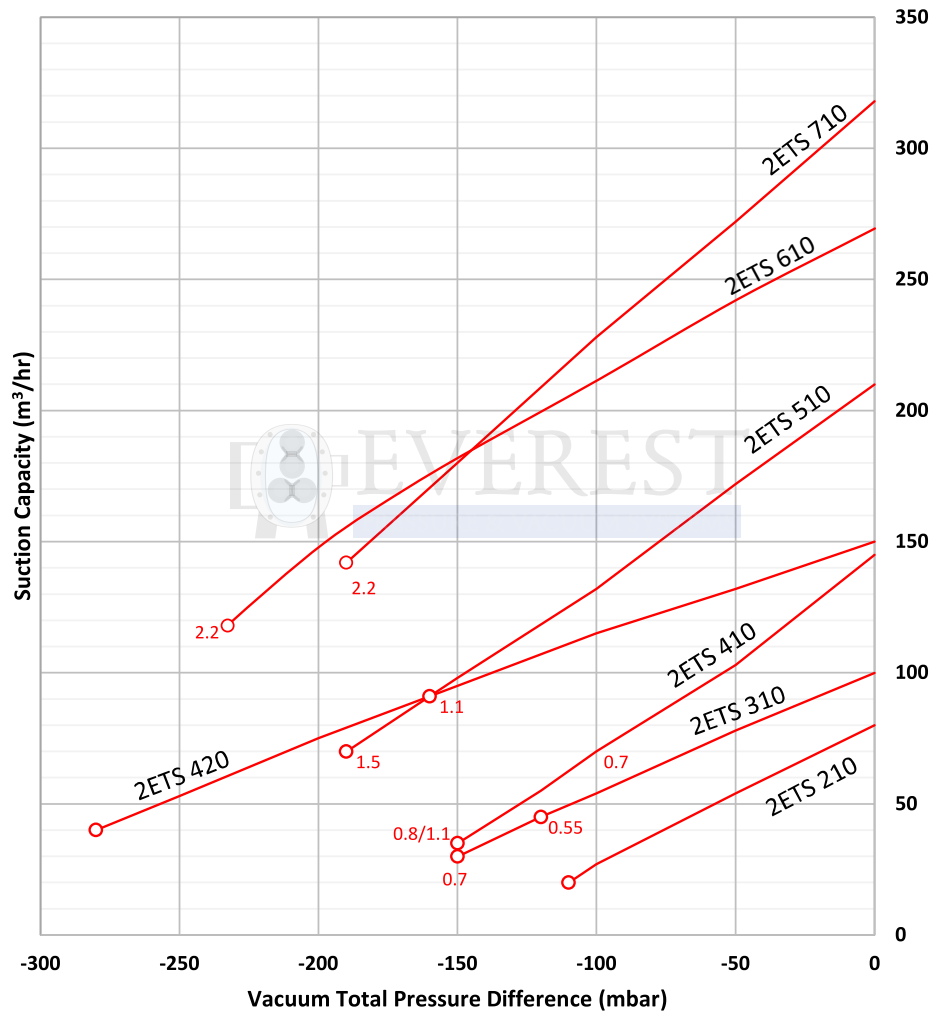

Tolerance on capacity ±10%

## 2ETS - SINGLE AND DOUBLE STAGE

## PERFORMANCE DATA FOR SIDE CHANNEL BLOWERS IN VACUUM AND PRESSURE OPERATION

MODEL	SINGLE/ THREE PHASE	SINGLE/ DOUBLE/ STAGE	BLOWER OPENING DETAILS	FREQUENCY (Hz)	MOTOR INPUT POWER (kW)	VOLUME FLOW RATE (m <sup>3</sup> /hr)	VACUUM (mbar)	PRESSURE (mbar)	NOISE LEVEL @ 1mt dB(A)	WEIGHT (kG)	FILTER	RELIEF VALVE
2ETS-210-H06	THREE	SINGLE	G1¼ (15 Deep)	50	0.25	80	-100	110	53	9	ESF-10	RV-01
2ETS-210-H16	THREE	SINGLE	G1¼ (15 Deep)	50	0.4	80	-120	130	53	10	ESF-10	RV-01

Specification are subject to change without notice. Side Channel Blowers are also available with motors suitable for 60 Hz frequency and different operating voltages. Contact Everest for further details.

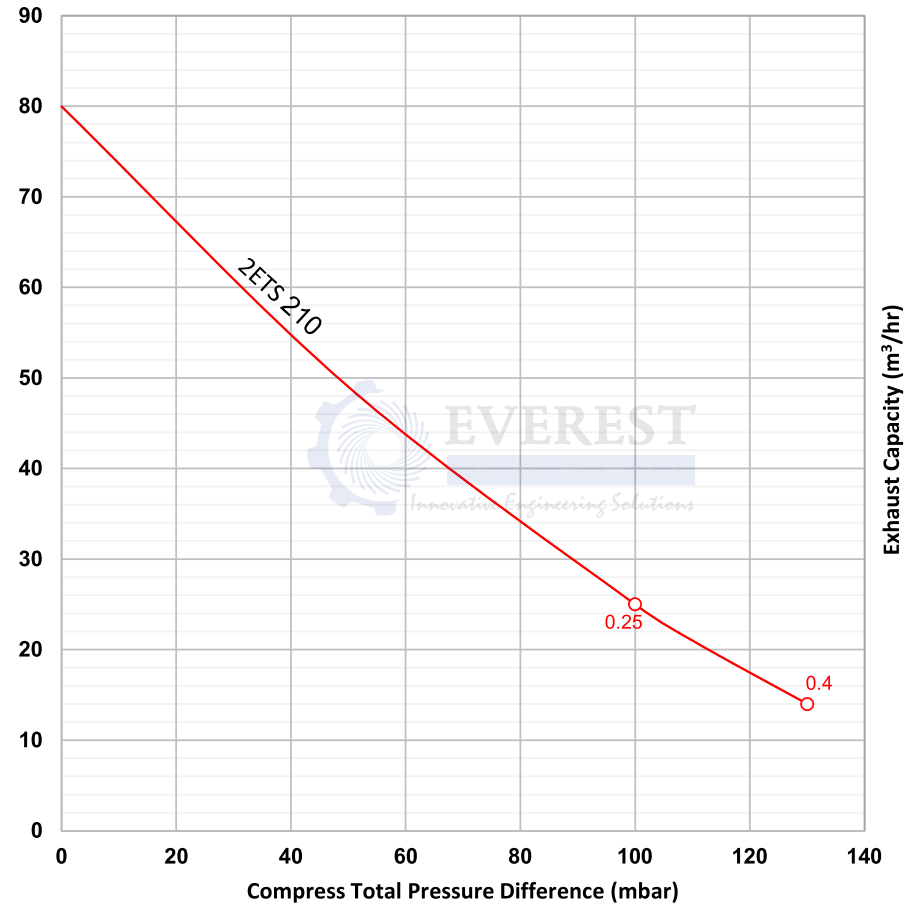
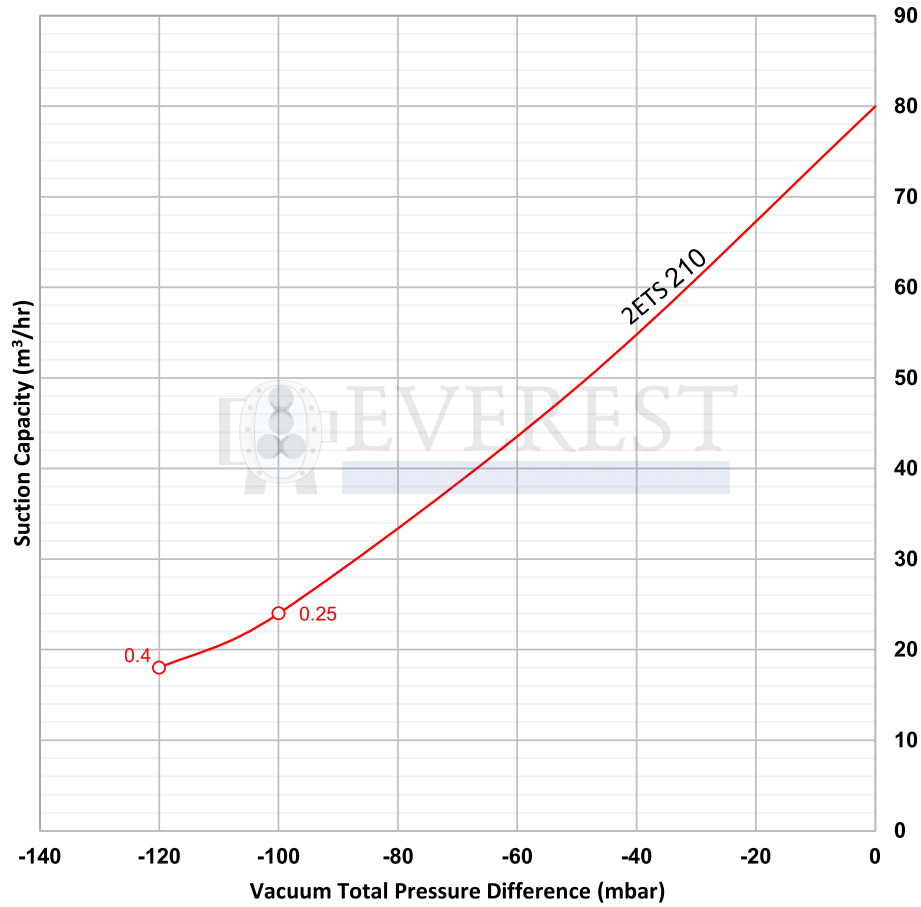

Tolerance on capacity ±10%



## 2ETS - SINGLE AND DOUBLE STAGE

## PERFORMANCE DATA FOR SIDE CHANNEL BLOWERS IN VACUUM AND PRESSURE OPERATION

MODEL	SINGLE/ THREE PHASE	SINGLE/ DOUBLE/ STAGE	BLOWER OPENING DETAILS	FREQUENCY (Hz)	MOTOR INPUT POWER (kW)	VOLUME FLOW RATE (m <sup>3</sup> /hr)	VACUUM (mbar)	PRESSURE (mbar)	NOISE LEVEL @ 1mt dB(A)	WEIGHT (kG)	FILTER	RELIEF VALVE
2ETS-310-H06	THREE	SINGLE	G1¼ (15 Deep)	50	0.55	100	-110	120	55	11	ESF-10	RV-01
2ETS-310-H16	THREE	SINGLE	G1¼ (15 Deep)	50	0.75	100	-150	150	55	12	ESF-10	RV-01
2ETS-320-H26	THREE	DOUBLE	G1¼ (15 Deep)	50	0.85	110	-200	230	58	17	ESF-10	RV-01
2ETS-320-H36	THREE	DOUBLE	G1¼ (15 Deep)	50	1.3	110	-280	290	58	18	ESF-10	RV-01
2ETS-330-H06	THREE	SINGLE	G1¼ (15 Deep)	50	0.55	140	-60	60	56	12	ESF-10	RV-01
2ETS-330-H16	THREE	SINGLE	G1¼ (15 Deep)	50	0.7	140	-100	100	56	13	ESF-10	RV-01

Specifications are subject to change without notice. Side Channel Blowers are also available with motors suitable for 60 Hz frequency and different operating voltages. Contact Everest for further details.

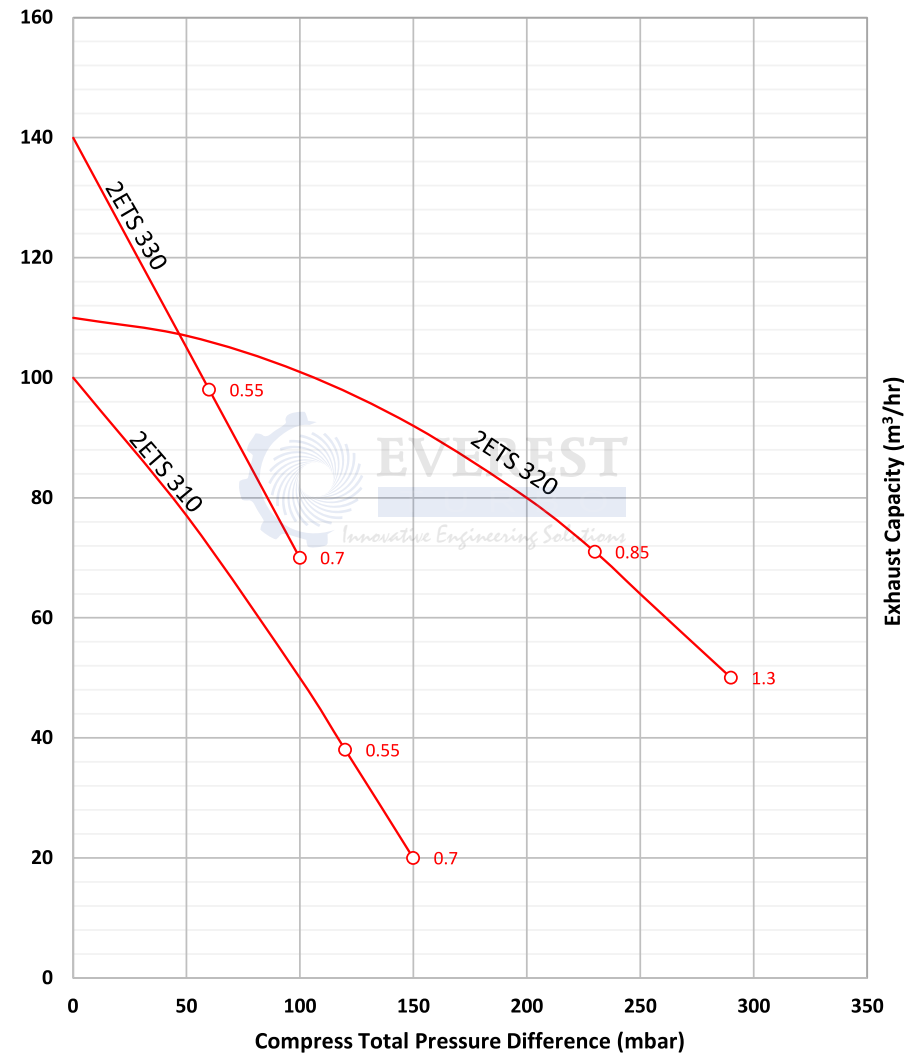
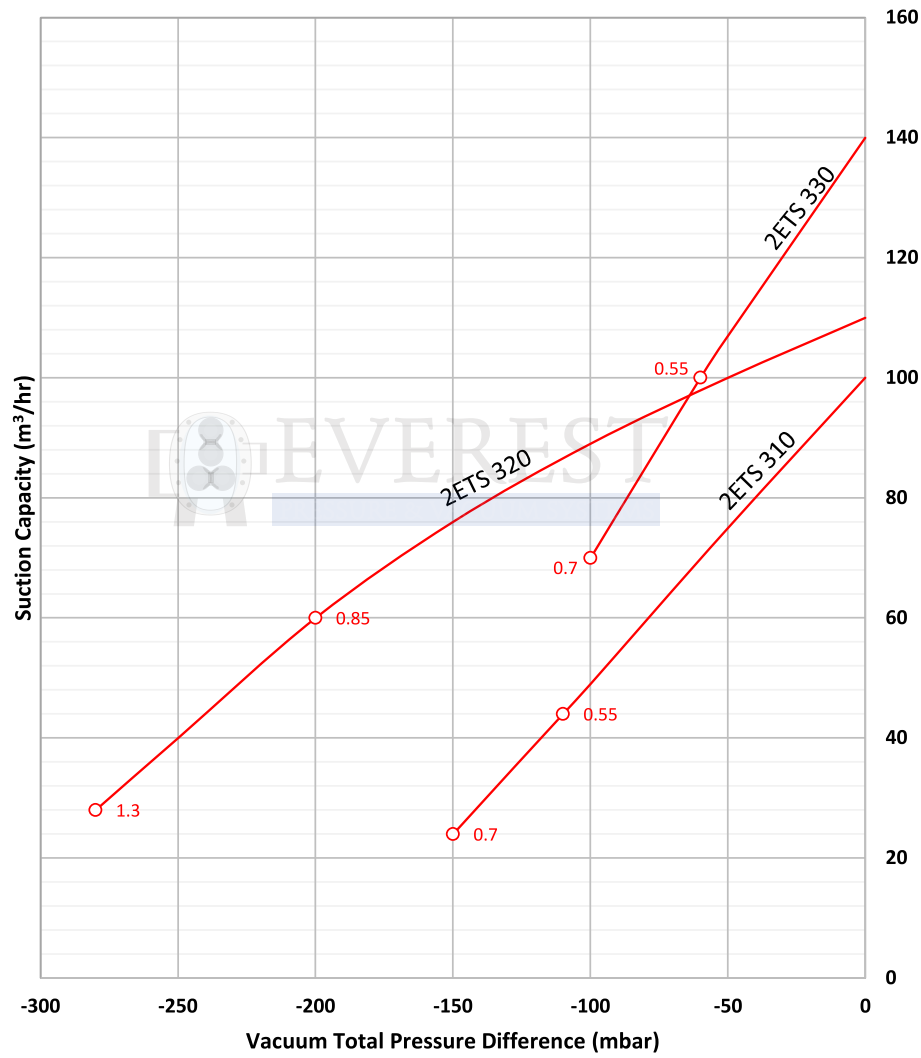

Tolerance on capacity ±10%

## 2ETS - SINGLE AND DOUBLE STAGE

## PERFORMANCE DATA FOR SIDE CHANNEL BLOWERS IN VACUUM AND PRESSURE OPERATION

MODEL	SINGLE/ THREE PHASE	SINGLE/ DOUBLE/ STAGE	BLOWER OPENING DETAILS	FREQUENCY (Hz)	MOTOR INPUT POWER (kW)	VOLUME FLOW RATE (m <sup>3</sup> /hr)	VACUUM (mbar)	PRESSURE (mbar)	NOISE LEVEL @ 1mt dB(A)	WEIGHT (kG)	FILTER	RELIEF VALVE
2ETS-410-H06	THREE	SINGLE	G1½ (15 Deep)	50	0.7	145	-120	120	63	13	ESF-12	RV-01
2ETS-410-H16	THREE	SINGLE	G1½ (15 Deep)	50	0.85	145	-160	160	63	16	ESF-12	RV-01
2ETS-410-H26	THREE	SINGLE	G1½ (15 Deep)	50	1.3	145	-170	200	63	17	ESF-12	RV-01
2ETS-420-H36	THREE	DOUBLE	G1½ (15 Deep)	50	1.6	150	-280	280	66	25	ESF-12	RV-01
2ETS-420-H46	THREE	DOUBLE	G1½ (15 Deep)	50	2.2	150	-330	440	66	27	ESF-12	RV-02
2ETS-490-H16	THREE	SINGLE	G1½ (15 Deep)	50	0.55	140	-120	120	63	14	ESF-12	RV-01

Specification are subject to change without notice. Side Channel Blowers are also available with motors suitable for 60 Hz frequency and different operating voltages. Contact Everest for further details.



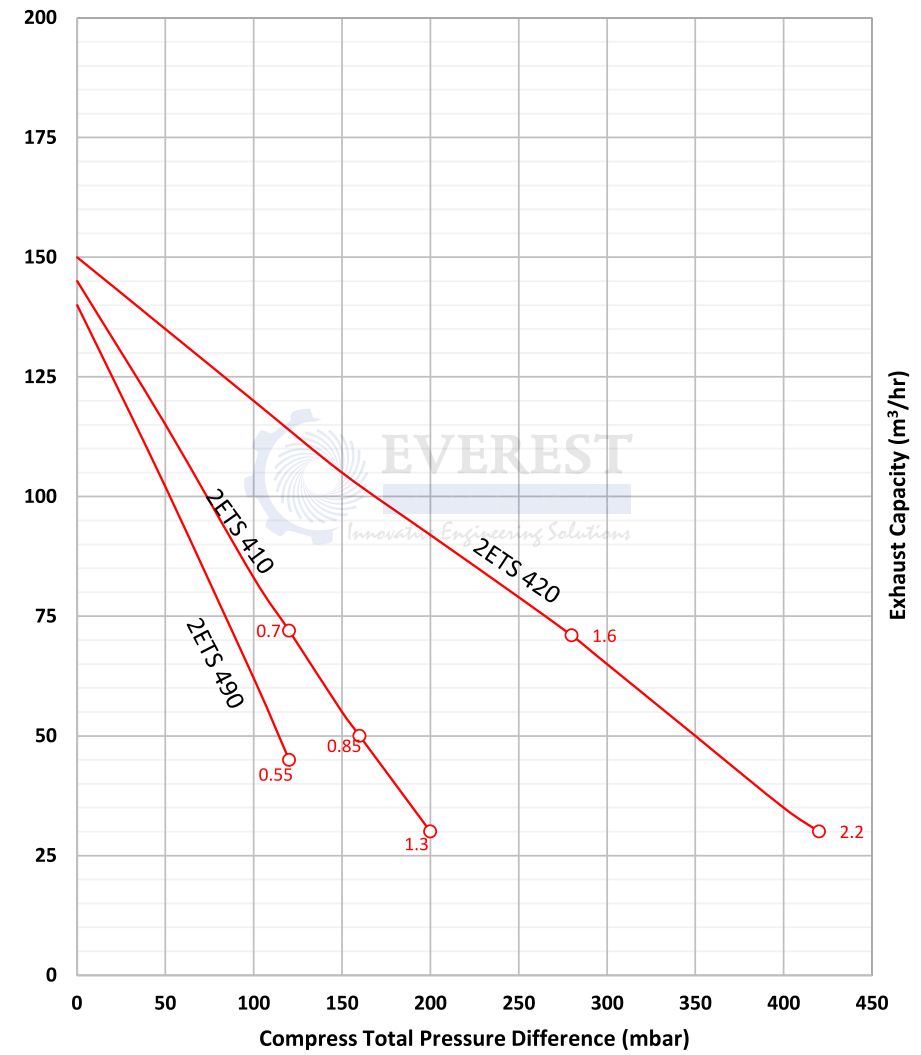
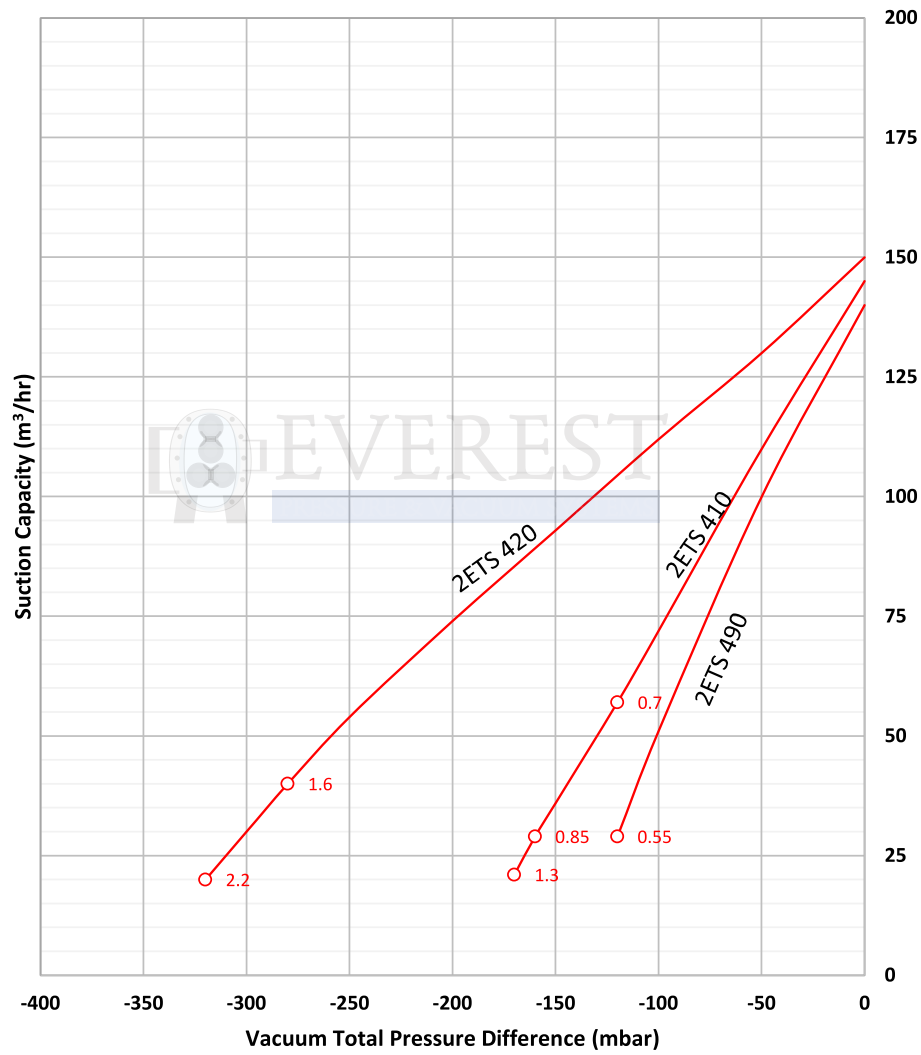

Tolerance on capacity ±10%

## 2ETS - SINGLE AND DOUBLE STAGE

## PERFORMANCE DATA FOR SIDE CHANNEL BLOWERS IN VACUUM AND PRESSURE OPERATION

MODEL	SINGLE/ THREE PHASE	SINGLE/ DOUBLE/ STAGE	BLOWER OPENING DETAILS	FREQUENCY (Hz)	MOTOR INPUT POWER (kW)	VOLUME FLOW RATE (m <sup>3</sup> /hr)	VACUUM (mbar)	PRESSURE (mbar)	NOISE LEVEL @ 1mt dB(A)	WEIGHT (kg)	FILTER	RELIEF VALVE
2ETS-510-H06	THREE	SINGLE	55 mmNB	50	0.85	210	-110	100	64	20	ESF-16	RV-01
2ETS-510-H16	THREE	SINGLE	55 mmNB	50	1.3	210	-170	170	64	22	ESF-16	RV-01
2ETS-510-H26	THREE	SINGLE	55 mmNB	50	1.6	210	-200	190	64	23	ESF-16	RV-01
2ETS-510-H36	THREE	SINGLE	55 mmNB	50	2.2	210	-220	270	64	25	ESF-16	RV-01
2ETS-520-H36	THREE	DOUBLE	G1¼ (15 Deep)	50	2.2	120	-470	460	64	40	ESF-16	RV-02
2ETS-520-H46	THREE	DOUBLE	58 mmNB	50	3	230	-340	410	72	40	ESF-16	RV-02
2ETS-520-H57	THREE	DOUBLE	55 mmNB	50	4	230	-390	490	72	44	ESF-16	RV-02
2ETS-530-H06	THREE	SINGLE	55 mmNB	50	0.85	270	-40	40	65	21	ESF-16	RV-01
2ETS-530-H16	THREE	SINGLE	55 mmNB	50	1.3	270	-120	110	65	23	ESF-16	RV-01
2ETS-530-H26	THREE	SINGLE	55 mmNB	50	1.6	270	-160	150	65	24	ESF-16	RV-01
2ETS-530-H36	THREE	SINGLE	55 mmNB	50	2.2	270	-220	230	65	26	ESF-16	RV-01
2ETS-590-H26	THREE	SINGLE	55 mmNB	50	1.1	210	-130	150	64	23	ESF-16	RV-01

Specification are subject to change without notice. Side Channel Blowers are also available with motors suitable for 60 Hz frequency and different operating voltages. Contact Everest for further details.

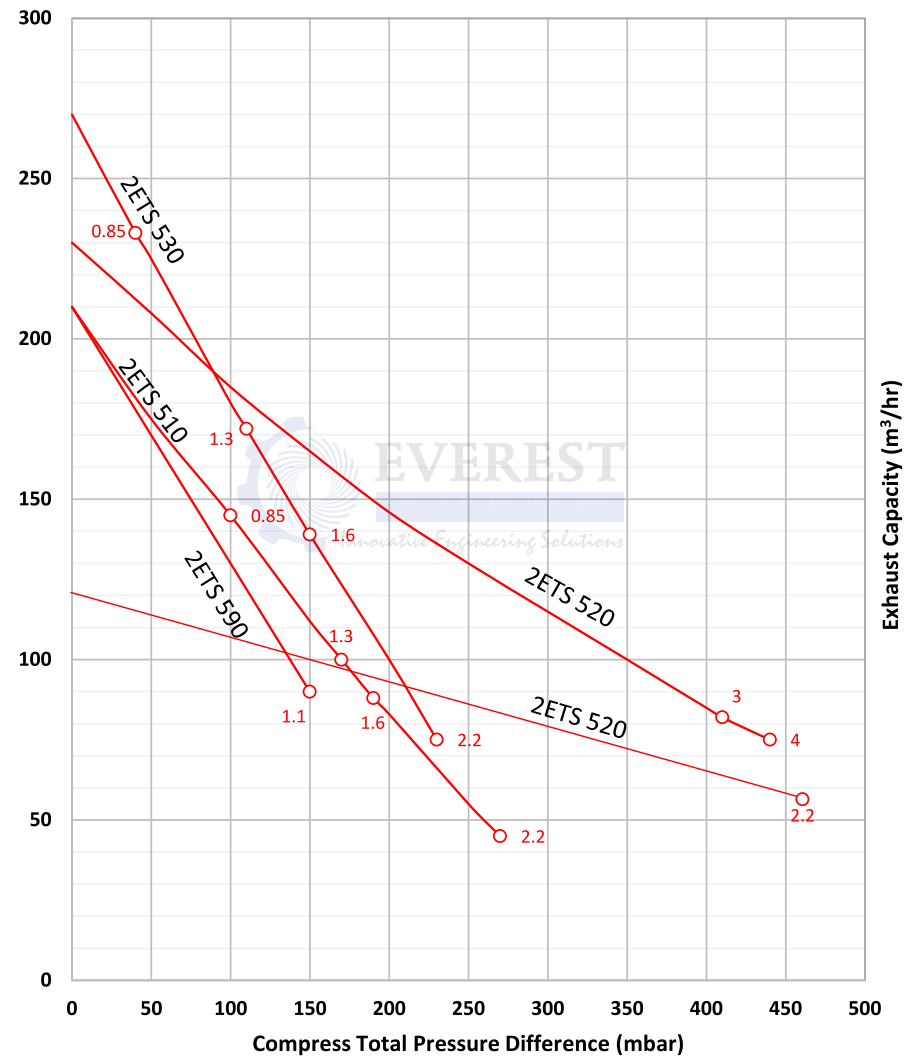
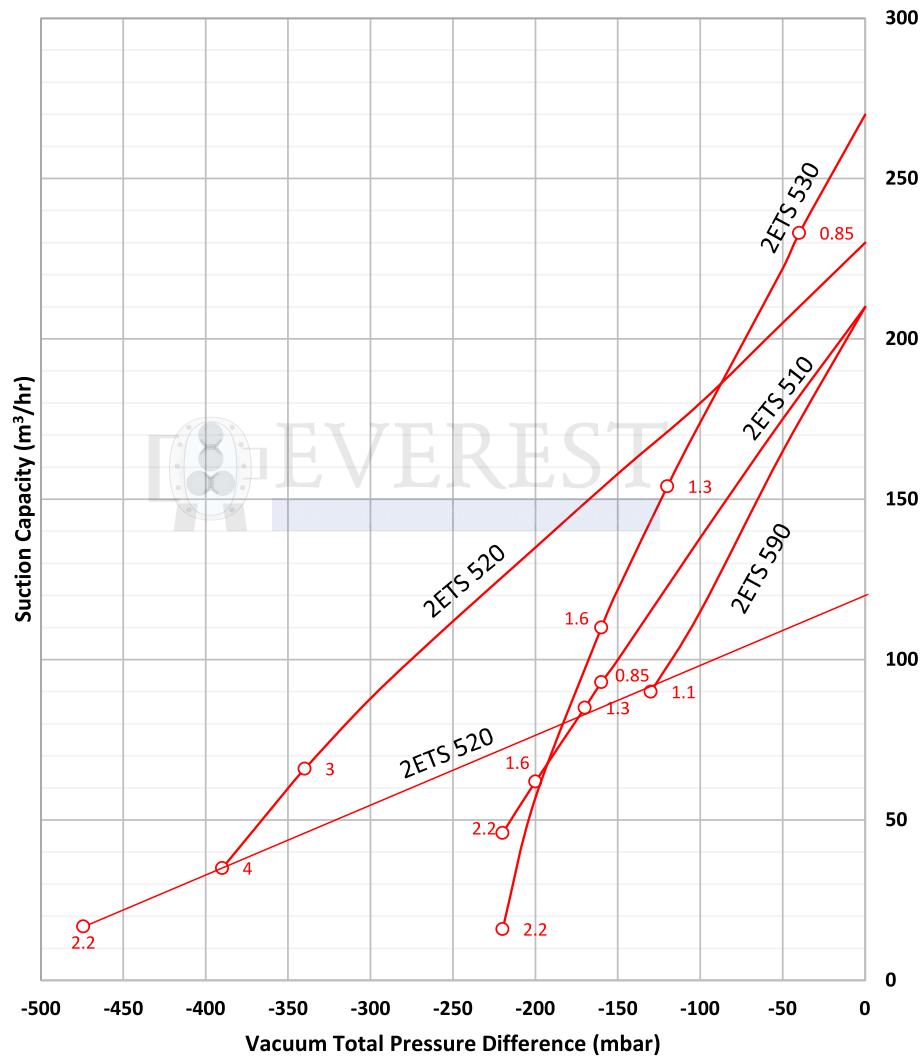

Tolerance on capacity ±10%



## 2ETS - SINGLE AND DOUBLE STAGE

## PERFORMANCE DATA FOR SIDE CHANNEL BLOWERS IN VACUUM AND PRESSURE OPERATION

MODEL	SINGLE/ THREE PHASE	SINGLE/ DOUBLE/ STAGE	BLOWER OPENING DETAILS	FREQUENCY (Hz)	MOTOR INPUT POWER (kW)	VOLUME FLOW RATE (m <sup>3</sup> /hr)	VACUUM (mbar)	PRESSURE (mbar)	NOISE LEVEL @ 1mt dB(A)	WEIGHT (kG)	FILTER	RELIEF VALVE
2ETS-610-H06	THREE	SINGLE	56 mmNB	50	1.6	265	-170	180	68	25	ESF-16	RV-01
2ETS-610-H16	THREE	SINGLE	56 mmNB	50	2.2	265	-235	220	69	28	ESF-16	RV-01
2ETS-610-H26	THREE	SINGLE	56 mmNB	50	3	265	-280	280	69	34	ESF-16	RV-01

Specification are subject to change without notice. Side Channel Blowers are also available with motors suitable for 60 Hz frequency and different operating voltages. Contact Everest for further details.

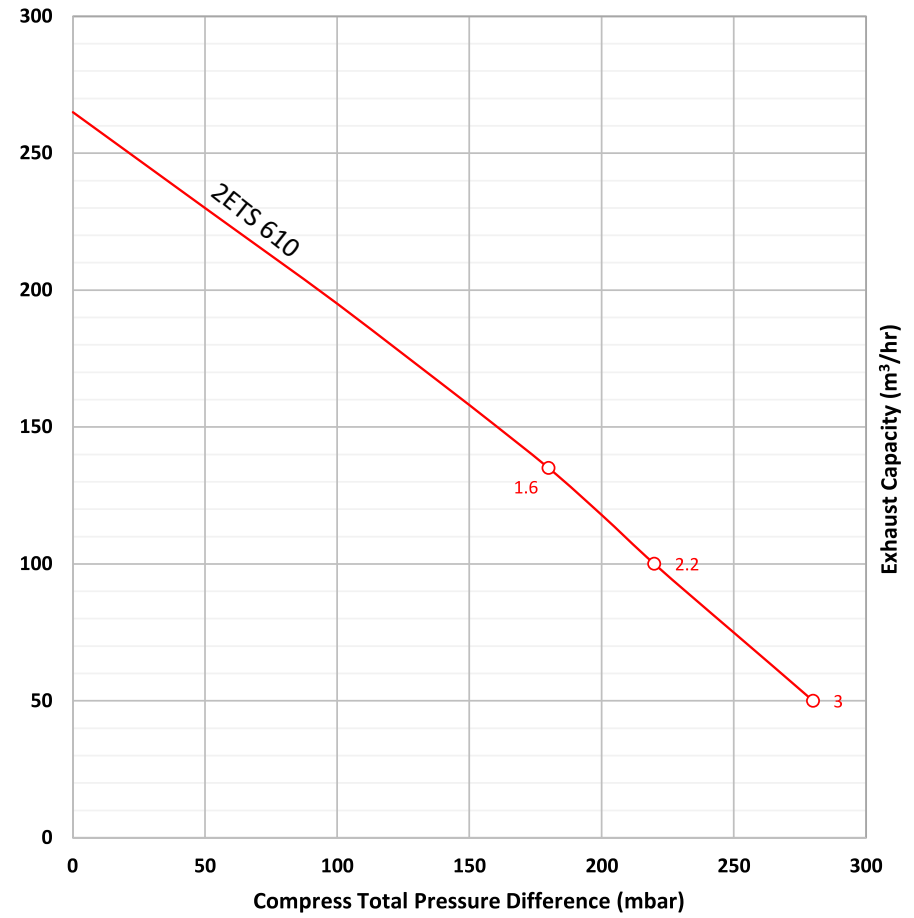
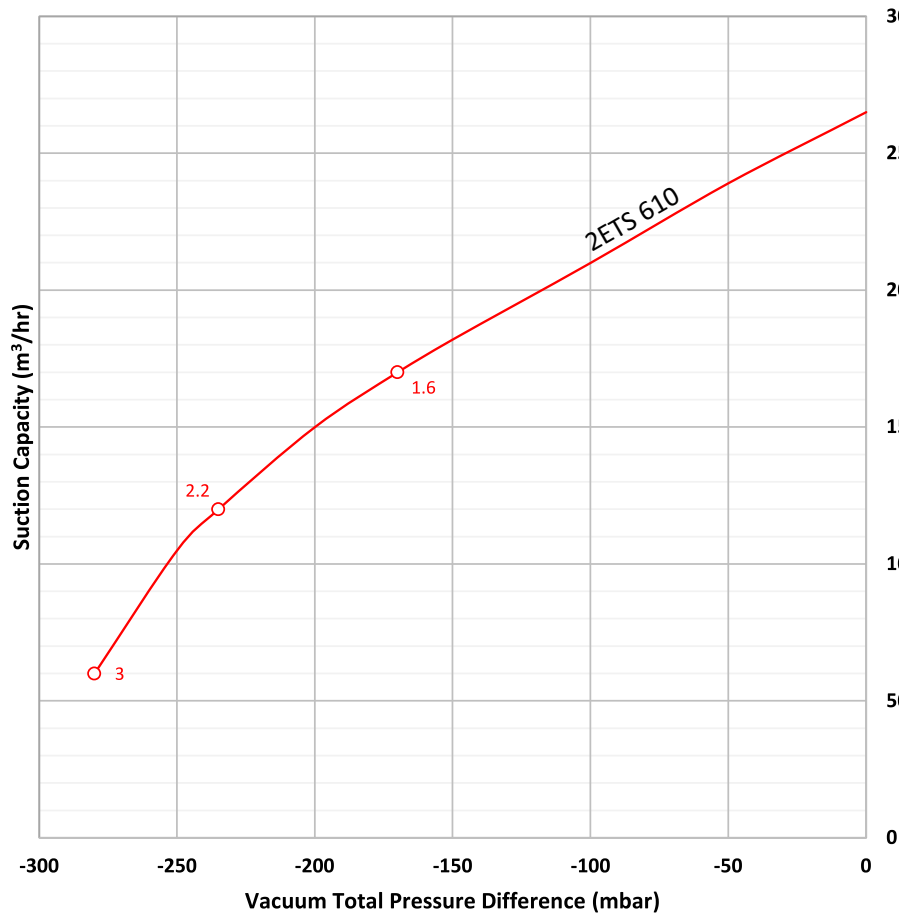

Tolerance on capacity ±10%

## 2ETS - SINGLE AND DOUBLE STAGE

## PERFORMANCE DATA FOR SIDE CHANNEL BLOWERS IN VACUUM AND PRESSURE OPERATION

MODEL	SINGLE/ THREE PHASE	SINGLE/ DOUBLE/ STAGE	BLOWER OPENING DETAILS	FREQUENCY (Hz)	MOTOR INPUT POWER (kW)	VOLUME FLOW RATE (m <sup>3</sup> /hr)	VACUUM (mbar)	PRESSURE (mbar)	NOISE LEVEL @ 1mt dB(A)	WEIGHT (kg)	FILTER	RELIEF VALVE
2ETS-710-H06	THREE	SINGLE	55 mmNB	50	1.6	318	-160	150	69	27	ESF-16	RV-01
2ETS-710-H16	THREE	SINGLE	55 mmNB	50	2.2	318	-210	200	69	30	ESF-16	RV-01
2ETS-710-H26	THREE	SINGLE	55 mmNB	50	3	318	-270	290	69	36	ESF-16	RV-01
2ETS-710-H37	THREE	SINGLE	55 mmNB	50	4	318	-290	330	69	40	ESF-16	RV-02
2ETS-720-H16	THREE	DOUBLE	55 mmNB	50	2.2	320	-220	210	73	43	ESF-16	RV-01
2ETS-720-H26	THREE	DOUBLE	55 mmNB	50	3	320	-280	260	73	48	ESF-16	RV-01
2ETS-720-H37	THREE	DOUBLE	55 mmNB	50	4.3	320	-360	380	73	54	ESF-16	RV-02
2ETS-720-H47	THREE	DOUBLE	55 mmNB	50	5.5	320	-440	500	73	66	ESF-16	RV-02
2ETS-720-H57	THREE	DOUBLE	55 mmNB	50	7.5	320	-440	570	73	73	ESF-16	RV-02
2ETS-730-H06	THREE	SINGLE	55 mmNB	50	1.6	420	-100	100	70	29	ESF-20	RV-01
2ETS-730-H16	THREE	SINGLE	55 mmNB	50	2.2	420	-170	170	70	32	ESF-20	RV-01
2ETS-730-H26	THREE	SINGLE	55 mmNB	50	3	420	-220	220	70	37	ESF-20	RV-01
2ETS-730-H37	THREE	SINGLE	55 mmNB	50	4	420	-260	310	70	43	ESF-20	RV-01
2ETS-740-H37	THREE	DOUBLE	55 mmNB	50	4	500	-150	140	74	54	ESF-20	RV-01
2ETS-740-H47	THREE	DOUBLE	58 mmNB	50	5.5	500	-240	260	74	69	ESF-20	RV-01
2ETS-740-H57	THREE	DOUBLE	58 mmNB	50	7.5	500	-240	320	74	75	ESF-20	RV-02
2ETS-790-H26	THREE	SINGLE	55 mmNB	50	2.2	320	-160	200	69	36	ESF-16	RV-01

Specification are subject to change without notice. Side Channel Blowers are also available with motors suitable for 60 Hz frequency and different operating voltages. Contact Everest for further details.



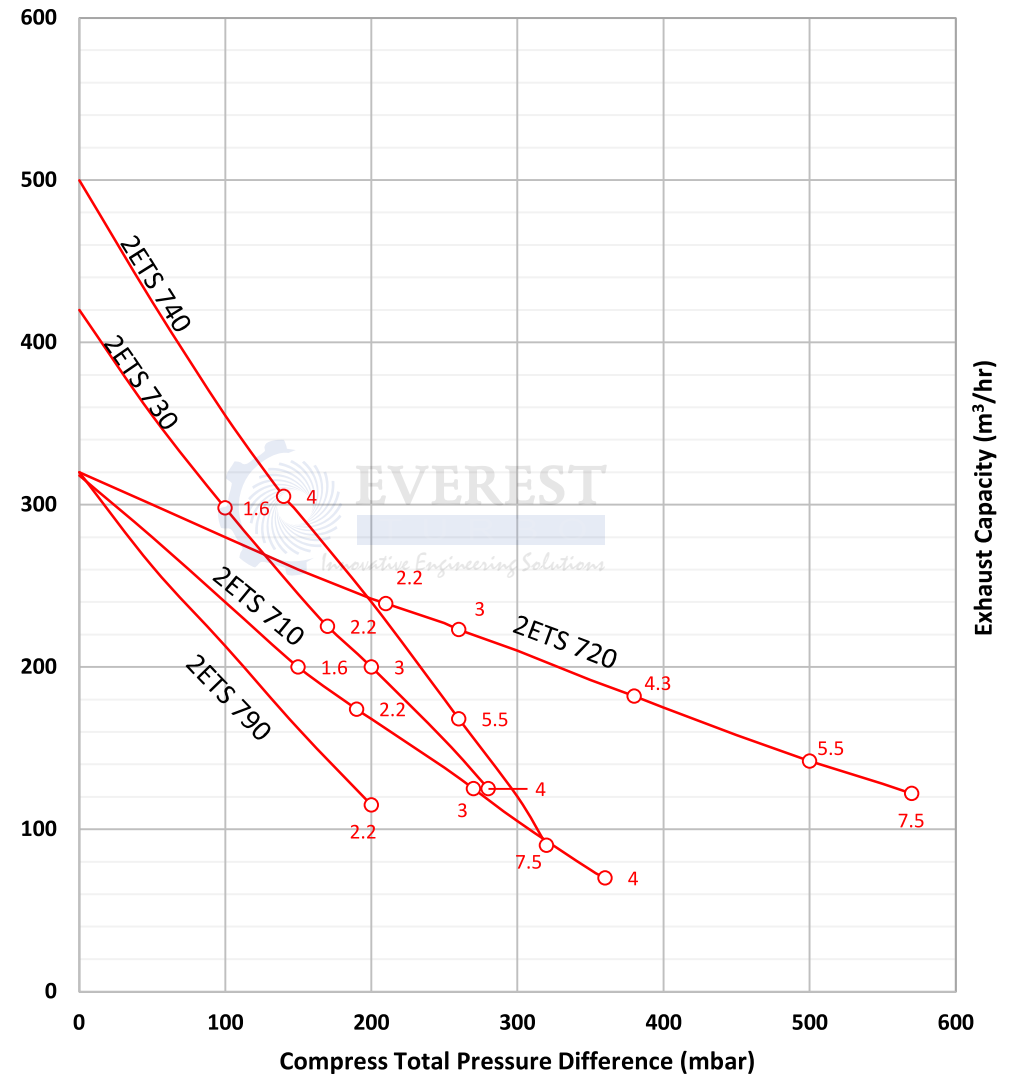
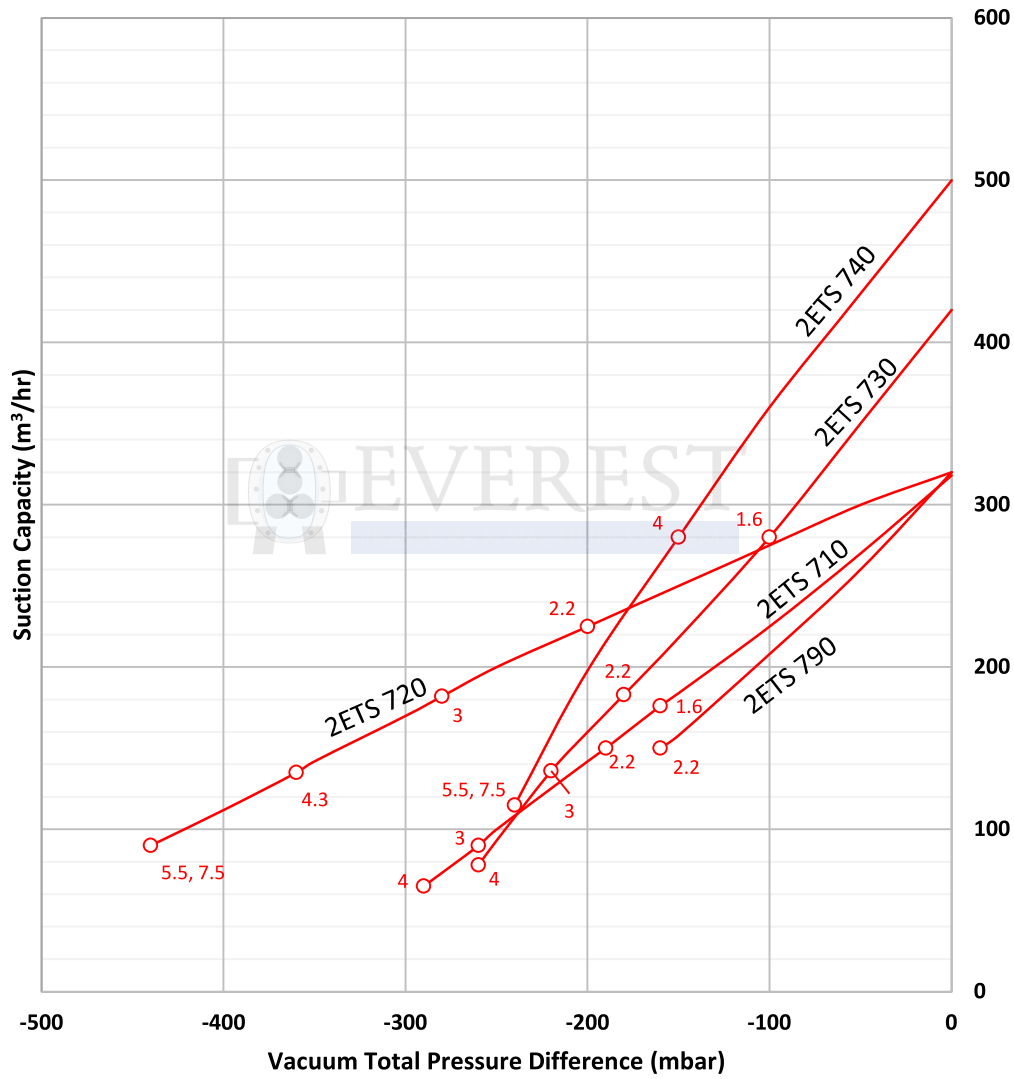

Tolerance on capacity ±10%

## 2ETS - SINGLE AND DOUBLE STAGE

## PERFORMANCE DATA FOR SIDE CHANNEL BLOWERS IN VACUUM AND PRESSURE OPERATION

MODEL	SINGLE/ THREE PHASE	SINGLE/ DOUBLE/ STAGE	BLOWER OPENING DETAILS	FREQUENCY (Hz)	MOTOR INPUT POWER (kW)	VOLUME FLOW RATE (m <sup>3</sup> /hr)	VACUUM (mbar)	PRESSURE (mbar)	NOISE LEVEL @ 1mt dB(A)	WEIGHT (kg)	FILTER	RELIEF VALVE
2ETS-810-H07	THREE	SINGLE	63.5 mmNB	50	4	530	-200	200	70	54	ESF-20	RV-01
2ETS-810-H17	THREE	SINGLE	63.5 mmNB	50	5.5	530	-300	300	70	63	ESF-20	RV-01
2ETS-810-H27	THREE	SINGLE	63.5 mmNB	50	7.5	530	-320	430	70	66	ESF-20	RV-02
2ETS-820-H17	THREE	DOUBLE	63.5 mmNB	50	5.5	520	-240	240	74	83	ESF-20	RV-01
2ETS-820-H27	THREE	DOUBLE	63.5 mmNB	50	7.5	520	-400	400	74	86	ESF-20	RV-02
2ETS-820-H37	THREE	DOUBLE	63.5 mmNB	50	11	520	-430	600	74	104	ESF-20	RV-02
2ETS-820-H47	THREE	DOUBLE	63.5 mmNB	50	15	520	-460	670	74	120	ESF-20	RV-02
2ETS-830-H07	THREE	SINGLE	63.5 mmNB	50	4	700	-150	140	70	57	ESF-20	RV-01
2ETS-830-H17	THREE	SINGLE	63.5 mmNB	50	5.5	700	-200	180	70	66	ESF-20	RV-01
2ETS-830-H27	THREE	SINGLE	63.5 mmNB	50	7.6	700	-270	260	70	61	ESF-20	RV-01
2ETS-840-H27	THREE	DOUBLE	63.5 mmNB	50	7.5	900	-200	180	74	91	ESF-32	RV-01
2ETS-840-H37	THREE	DOUBLE	63.5 mmNB	50	11	900	-280	370	74	110	ESF-32	RV-02

Specification are subject to change without notice. Side Channel Blowers are also available with motors suitable for 60 Hz frequency and different operating voltages. Contact Everest for further details.

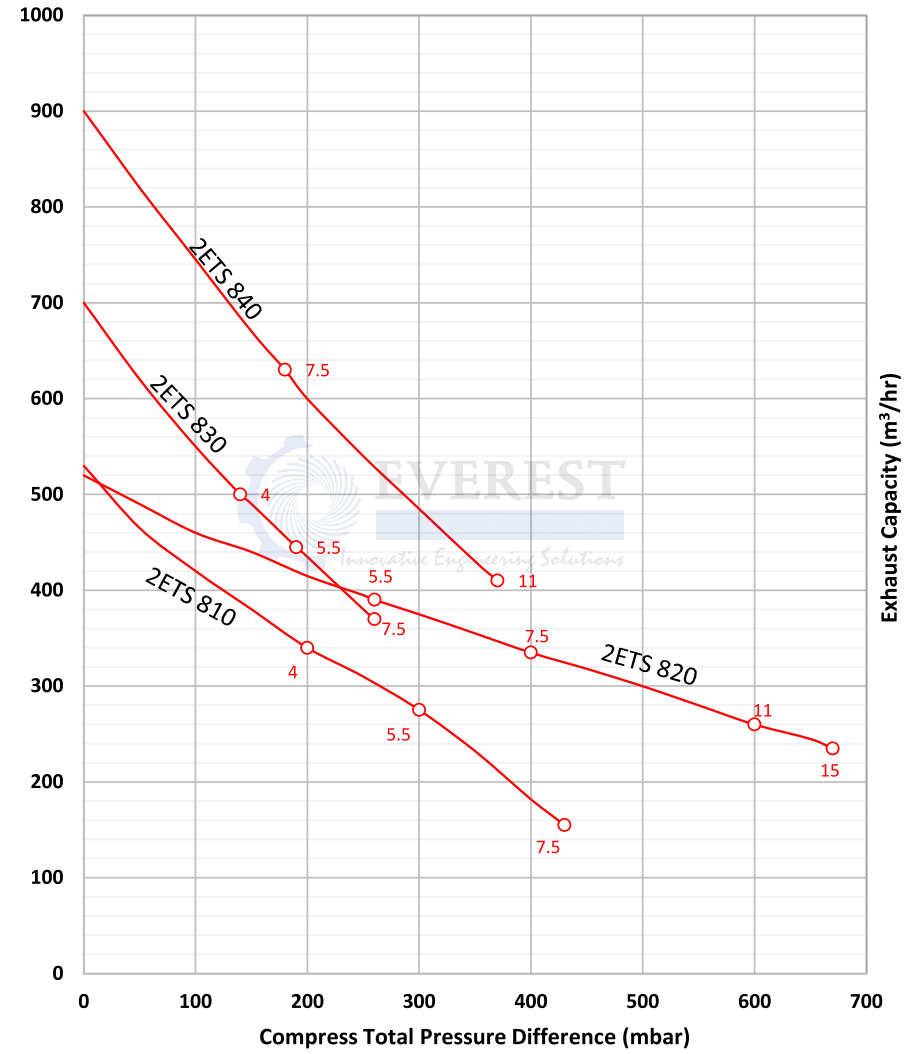
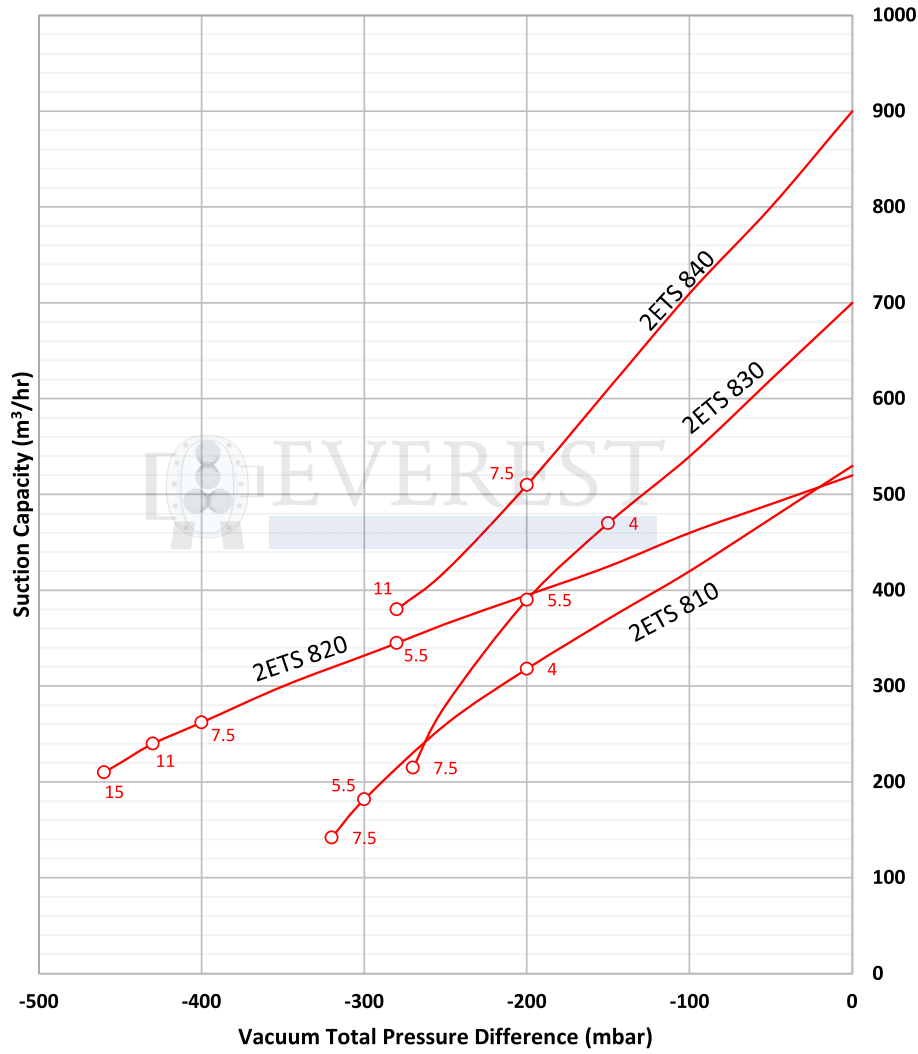

Tolerance on capacity ±10%

## 2ETS - SINGLE AND DOUBLE STAGE

## PERFORMANCE DATA FOR SIDE CHANNEL BLOWERS IN VACUUM AND PRESSURE OPERATION

MODEL	SINGLE/ THREE PHASE	SINGLE/ DOUBLE/ STAGE	BLOWER OPENING DETAILS	FREQUENCY (Hz)	MOTOR INPUT POWER (kW)	VOLUME FLOW RATE (m <sup>3</sup> /hr)	VACUUM (mbar)	PRESSURE (mbar)	NOISE LEVEL @ 1mt dB(A)	WEIGHT (kg)	FILTER	RELIEF VALVE
2ETS-910-H07	THREE	SINGLE	100 mmNB	50	8.5	1050	-210	210	74	93	ESF-32	RV-01
2ETS-910-H17	THREE	SINGLE	100 mmNB	50	12.5	1050	-280	270	74	116	ESF-32	RV-01
2ETS-910-H27	THREE	SINGLE	100 mmNB	50	15	1050	-290	280	74	120	ESF-32	RV-01
2ETS-910-H37	THREE	SINGLE	100 mmNB	50	18.5	1050	-340	460	74	126	ESF-32	RV-02
2ETS-920-H17	THREE	DOUBLE	100 mmNB	50	12.5	1110	-300	370	74	187	ESF-32	RV-02
2ETS-920-H27	THREE	DOUBLE	100 mmNB	50	16.5	1110	-410	370	74	197	ESF-32	RV-02
2ETS-920-H37	THREE	DOUBLE	100 mmNB	50	20	1110	-440	500	74	204	ESF-32	RV-02
2ETS-920-H47	THREE	DOUBLE	100 mmNB	50	25	1110	-440	590	74	211	ESF-32	RV-02
2ETS-930-H07	THREE	SINGLE	100 mmNB	50	8.5	1370	-120	110	75	98	ESF-32	RV-01
2ETS-930-H17	THREE	SINGLE	100 mmNB	50	12.5	1370	-210	190	75	121	ESF-32	RV-01
2ETS-930-H27	THREE	SINGLE	100 mmNB	50	15	1370	-250	260	75	128	ESF-32	RV-01
2ETS-930-H37	THREE	SINGLE	100 mmNB	50	18.5	1370	-310	320	75	131	ESF-32	RV-02
2ETS-940-H27	THREE	DOUBLE	100 mmNB	50	15	1940	-130	110	75	187	ESF-32	RV-01
2ETS-940-H37	THREE	DOUBLE	100 mmNB	50	20	1940	-220	200	75	212	ESF-32	RV-01
2ETS-940-H47	THREE	DOUBLE	100 mmNB	50	25	1940	-310	270	75	219	ESF-32	RV-01
2ETS-943-H27*	THREE	DOUBLE	130 mmNB	50	15	2050	-160	170	75	220	ESF-32	RV-01
2ETS-943-H37*	THREE	DOUBLE	130 mmNB	50	20	2050	-250	230	75	230	ESF-32	RV-01
2ETS-943-H47*	THREE	DOUBLE	130 mmNB	50	25	2330	-310	270	75	235	ESF-32	RV-01

Specification are subject to change without notice. Side Channel Blowers are also available with motors suitable for 60 Hz frequency and different operating voltages. Contact Everest for further details.

\* - Vertical installation on the end casing only.

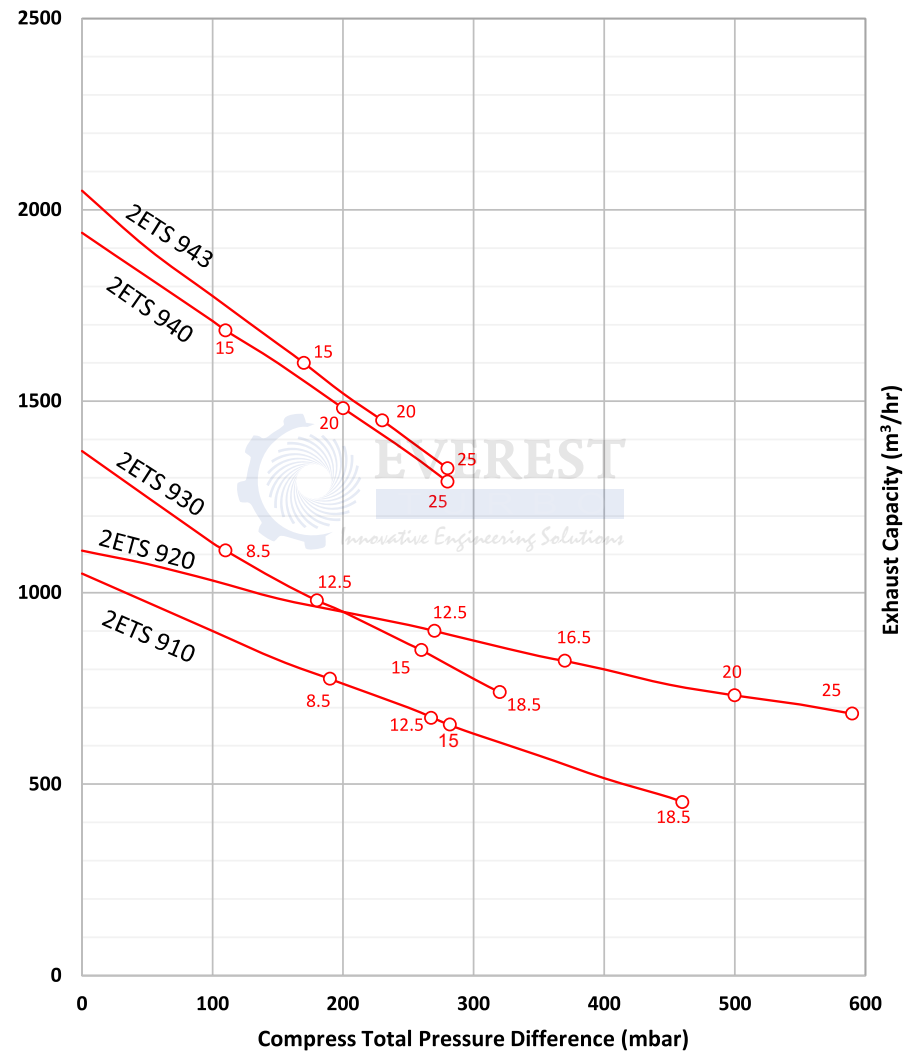
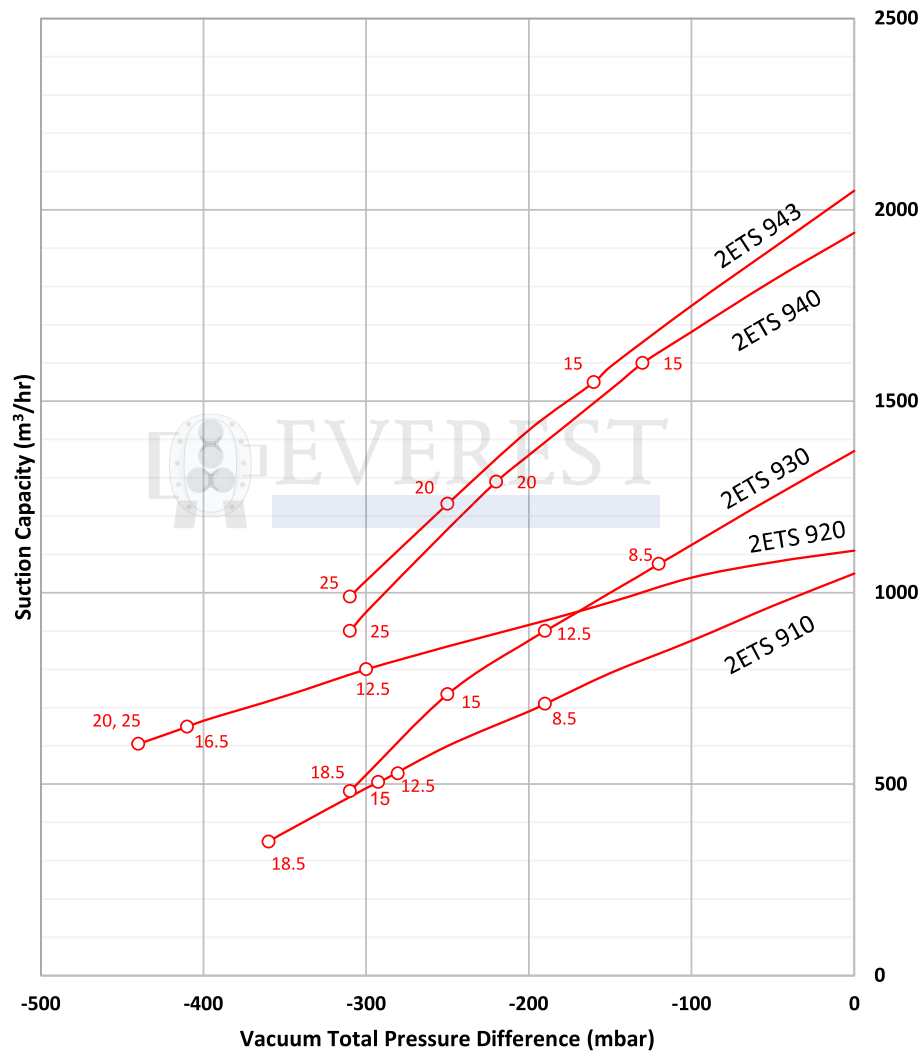

Tolerance on capacity ±10%

## 4ETS - SINGLE AND DOUBLE STAGE

## PERFORMANCE DATA FOR SIDE CHANNEL BLOWERS IN VACUUM AND PRESSURE OPERATION

MODEL	SINGLE/ THREE PHASE	SINGLE/ DOUBLE/ STAGE	BLOWER OPENING DETAILS	FREQUENCY (Hz)	MOTOR INPUT POWER (kW)	VOLUME FLOW RATE (m <sup>3</sup> /hr)	VACUUM (mbar)	PRESSURE (mbar)	NOISE LEVEL @ 1mt dB(A)	WEIGHT (kg)	FILTER	RELIEF VALVE
4ETS-210-H16	THREE	SINGLE	G1¼ (15 Deep)	50	0.55	47	-230	290	57	16	ESF-10	RV-01
4ETS-310-H16	THREE	SINGLE	G1¼ (18 Deep)	50	0.55	66	-250	250	57	16	ESF-10	RV-01
4ETS-310-H26	THREE	SINGLE	G1¼ (18 Deep)	50	0.81	66	-280	350	57	17	ESF-10	RV-02
4ETS-410-H16	THREE	SINGLE	G1¼ (18 Deep)	50	1.1	87	-300	380	58	23	ESF-10	RV-02
4ETS-510-H16	THREE	SINGLE	G1¼ (18 Deep)	50	1.5	120	-310	360	64	26	ESF-10	RV-02
4ETS-510-H26	THREE	SINGLE	G1¼ (18 Deep)	50	2.2	120	-310	470	64	29	ESF-10	RV-02
4ETS-610-H16	THREE	SINGLE	G1¼ (18 Deep)	50	2.2	165	-340	360	65	32	ESF-10	RV-02
4ETS-610-H36	THREE	SINGLE	G1¼ (18 Deep)	50	3.3	165	-340	480	65	35	ESF-10	RV-02

Specification are subject to change without notice. Side Channel Blowers are also available with motors suitable for 60 Hz frequency and different operating voltages. Contact Everest for further details.



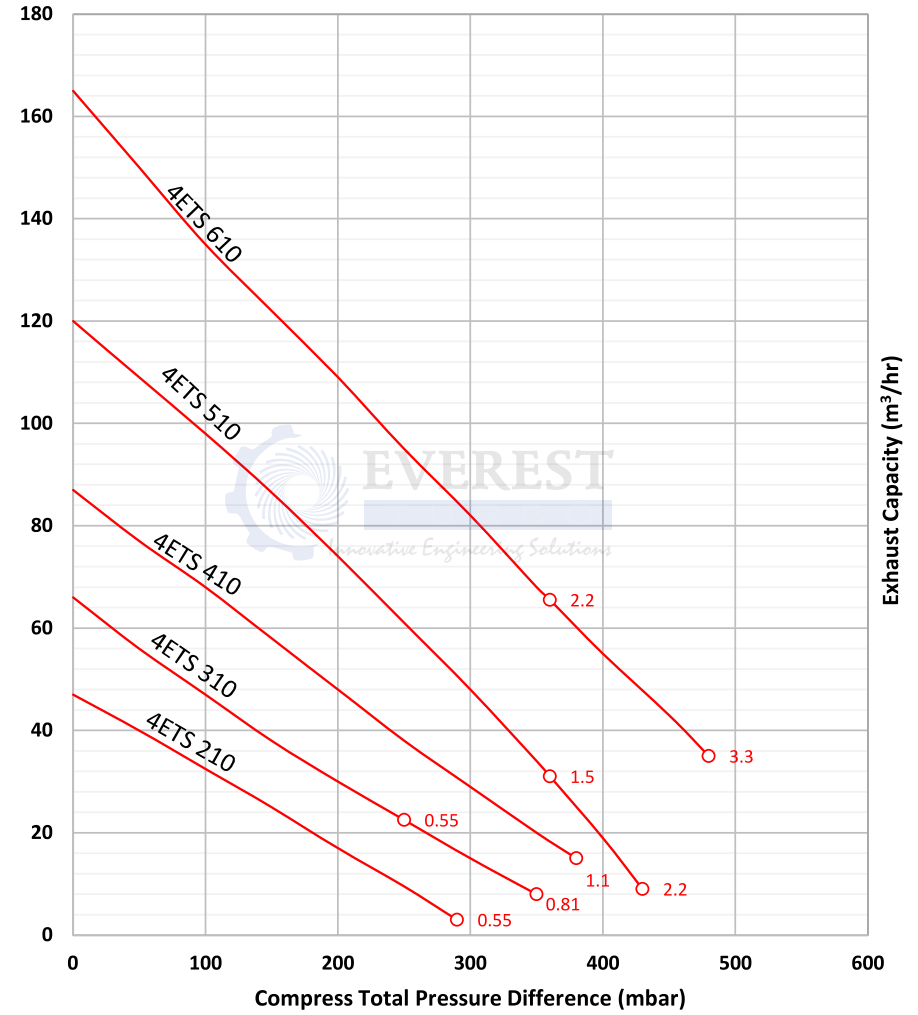
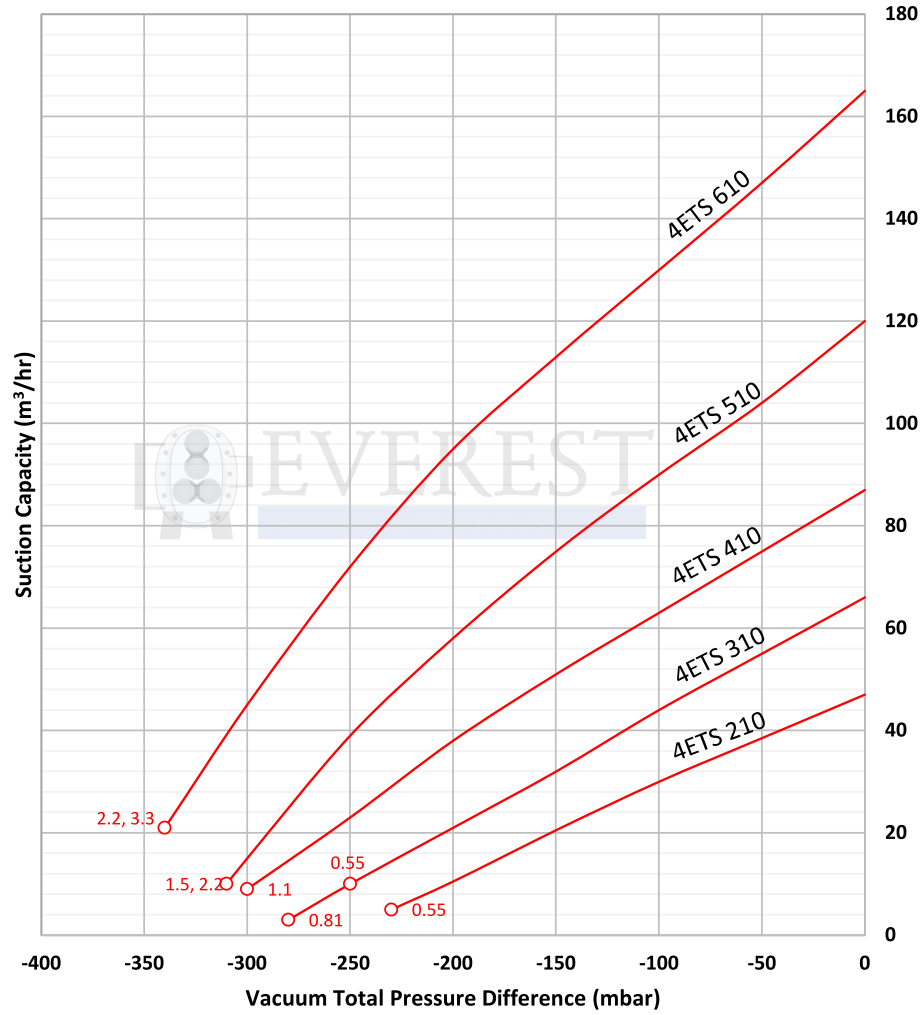

Tolerance on capacity ±10%

## 4ETS - SINGLE AND DOUBLE STAGE

## PERFORMANCE DATA FOR SIDE CHANNEL BLOWERS IN VACUUM AND PRESSURE OPERATION

MODEL	SINGLE/ THREE PHASE	SINGLE/ DOUBLE/ STAGE	BLOWER OPENING DETAILS	FREQUENCY (Hz)	MOTOR INPUT POWER (kW)	VOLUME FLOW RATE (m <sup>3</sup> /hr)	VACUUM (mbar)	PRESSURE (mbar)	NOISE LEVEL @ 1mt dB(A)	WEIGHT (kg)	FILTER	RELIEF VALVE
4ETS-220-H26	THREE	DOUBLE	G1¼ (18 Deep)	50	0.81	47	-370	490	58	24	ESF-10	RV-02
4ETS-220-H56	THREE	DOUBLE	G1¼ (15 Deep)	50	1.5	47	-370	650	58	28	ESF-10	RV-02
4ETS-320-H46	THREE	DOUBLE	G1¼ (18 Deep)	50	1.1	65	-400	480	59	29	ESF-10	RV-02
4ETS-320-H56	THREE	DOUBLE	G1¼ (18 Deep)	50	1.5	65	-440	540	59	30	ESF-10	RV-02
4ETS-420-H26	THREE	DOUBLE	G1¼ (18 Deep)	50	1.5	87	-480	450	61	33	ESF-12	RV-02
4ETS-420-H56	THREE	DOUBLE	G1¼ (18 Deep)	50	3.3	87	-500	750	61	39	ESF-12	RV-02
4ETS-520-H26	THREE	DOUBLE	G1¼ (18 Deep)	50	2.2	120	-470	460	64	40	ESF-16	RV-02
4ETS-520-H77	THREE	DOUBLE	G1¼ (18 Deep)	50	4	120	-500	820	65	51	ESF-16	RV-02
4ETS-620-H36	THREE	DOUBLE	G1¼ (18 Deep)	50	3.3	165	-460	500	67	48	ESF-16	RV-02
4ETS-620-H57	THREE	DOUBLE	G1¼ (18 Deep)	50	5.7	165	-460	740	68	65	ESF-16	RV-02
4ETS-630-H67	THREE	SINGLE	G1¼ (18 Deep)	50	7.5	170	-730	1040	72	86	ESF-16	RV-02

Specification are subject to change without notice. Side Channel Blowers are also available with motors suitable for 60 Hz frequency and different operating voltages. Contact Everest for further details.

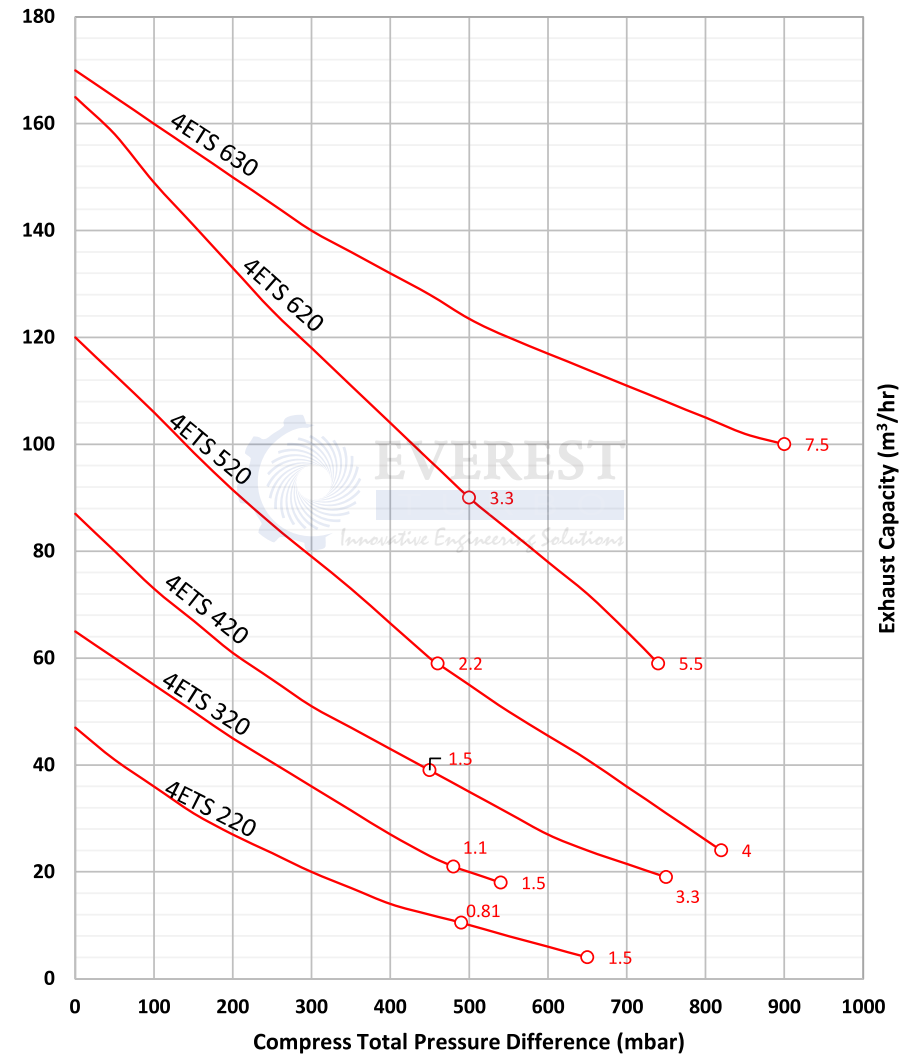
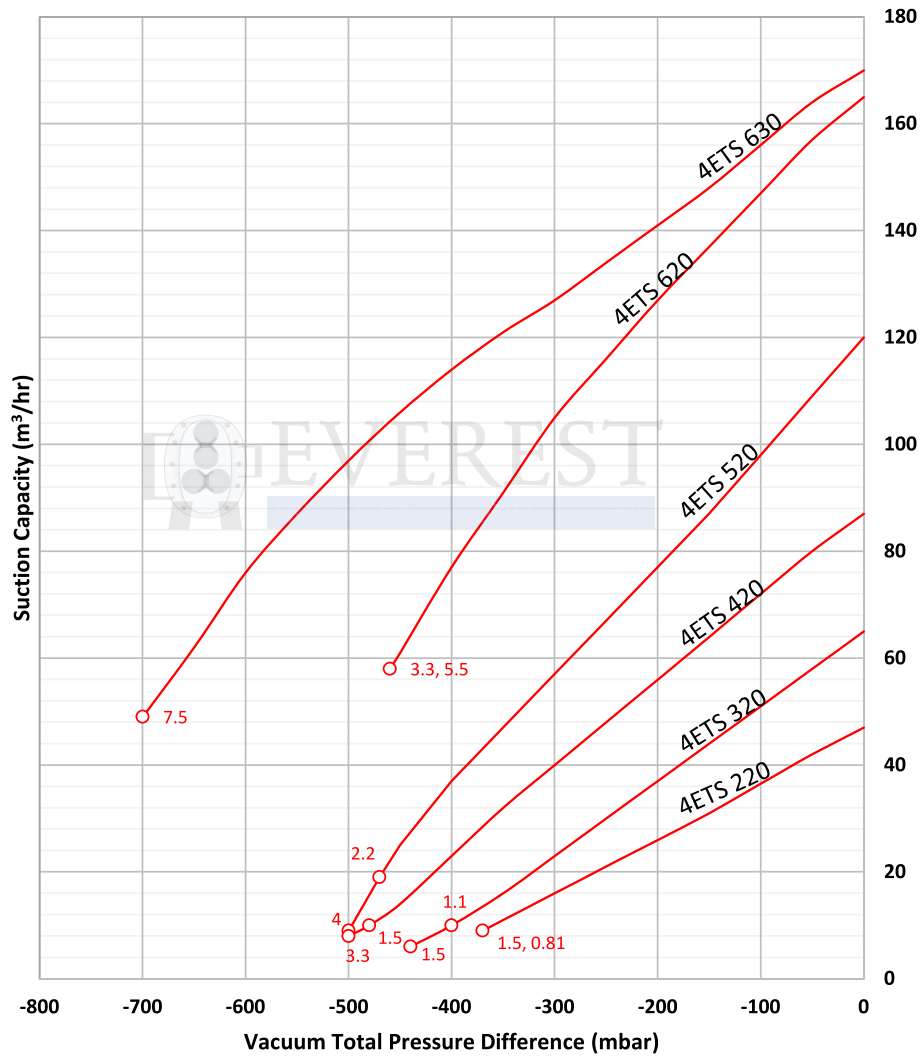

Tolerance on capacity ±10%

## SPARES & ACCESSORIES



AIR FILTER



MUFFLER

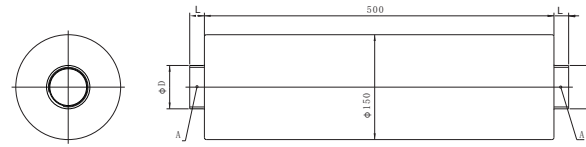

Opening Thread Size -A	Dia (mm)	L (mm)
G 2.5"	78	60
G 2"	62	60
G 1.5"	48	50
G 1.25"	40	50

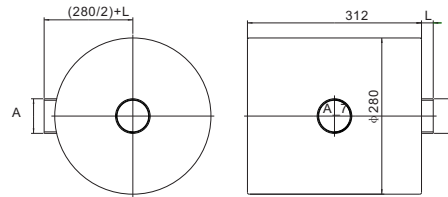

Opening Thread Size -A	Line Size (mm MB)
G 2.5"	65
G 2"	50
G 1.5"	40
G 1.25"	32



PRESSURE RELIEF VALVE



FILTERING BARRELS

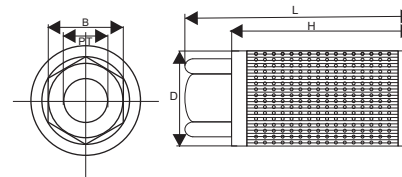

Model	Pipe Thread	D (mm)	L (mm)	H (mm)	B (mm)	Filter Rating (μ)	(l/min)	(Kg)
ESF-10	1.25"	71	186	170	54	100	210	0.35
ESF-12	1.5"	85	196	182	65	100	285	0.49
ESF-16	2"	103	215	202	75	100	395	0.65
ESF-20	2.5"	148	274	252	97	100	750	1.20
ESF-32	4"	208	380	357	142	100	1000	2.45

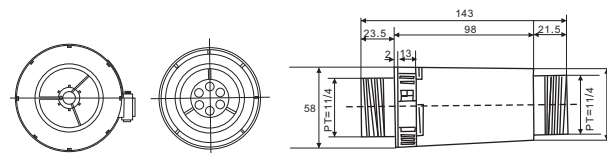

Model	Thread Size	L (mm)	Pressure Range
RV-01	1.25"	143	0 -300mbar
RV-02	1.25"	143	300 -800mbar

## APPLICATION

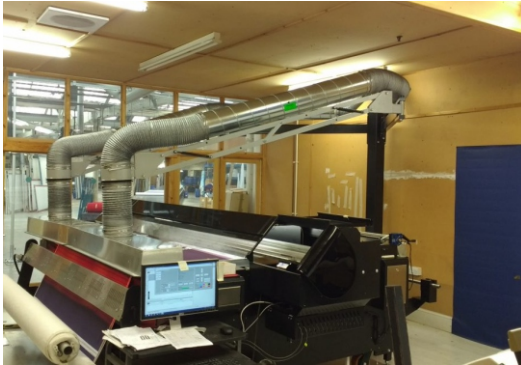

### APPLICATIONS FOR EVEREST SIDE CHANNEL BLOWERS

Everest Side Channel Blowers offer a wide field of application facilities wherever the use of air as energy supply leads to optimum results. The fields of application listed below present just a small summary therefore of the wide range of possible uses of these units.

- Pneumatic Air Tube Systems
- Pneumatic Conveying Systems
- Vacuum Cleaning Systems
- Vacuum Lifting Gear
- Vacuum Transport Systems
- Bottle Filling Stations
- Printing Machines
- Screen Printing Machines
- Air-Cushion Tables
- Drying Systems
- Welding Fume Extraction
- Textile Machinery
- Agricultural Machines
- Dental Equipment
- Water Treatment
- Fish Pond Aeration
- Aquarium Aeration
- Aeration Of Galvanic Tanks





## CONTACT US

### EVEREST BLOWERS PRIVATE LIMITED



Corporate Office

**Sales Contact :**  
**9367444050**



Sales

**info@bigroup.in**  
**Sales Contact :**  
**9367444050**



Web

<https://www.bigroup.in/>



**Service Contact :**  
**9367444041**



Corporate Office

**BI Marketing ,**  
**No: 21, 3rd Phase,**  
**TVK Industrial Estate,**  
**Guindy, Chennai,**

Follow us



ISO 9001:2015 | ISO14001:2015 | OHSAS 18001:2007 Certified

CAT ETS Rev.2 March 2020

## WE ARE THE BIGGEST BLOWER MANUFACTURER IN INDIA

- **Leading By Innovation**
- **Technically Stronger**
- **Physically More Connected**
- **Ready to take INDIA Global**